

Miniature Timer for G2R Relay Socket

- Multiple operating modes, DIP switch selectable, ON-delay, Interval, Repeat cycle ON-start/OFF-start
- Standard multiple time ranges:
Short range (0.15 to 10 min)
Long range (0.1 min to 10 hrs)
- Pin configuration compatible with G2R Relay and mounts to the P2R/P2RF Socket.

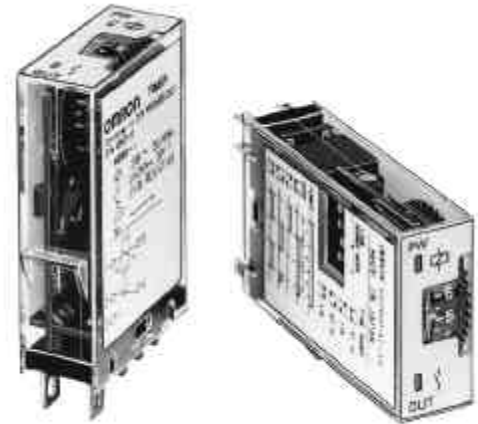

Ordering Information

Supply voltage	Time-limit contact	Short-time range model (0.1 s to 10 min)	Long-time range model (0.1 min to 10 h)
24 VAC; 12, 24 VDC	SPDT	H3RN-1	H3RN-11
	DPST-NO	H3RN-2	H3RN-21

Note: Specify both the model number and supply voltage when ordering.

Example: H3RN-1 24 VAC

Supply voltage

MODEL NUMBER LEGEND

H3RN -
 1 2

1. Output

- 1: SPDT
- 2: DPST-NO

2. Time Range

- None: Short-time range (0.1 s to 10 min)
- 1: Long-time range (0.1 min to 10 hrs)

ACCESSORIES (ORDER SEPARATELY)

Connecting Socket

Timer	Track-mounting/Front-connecting socket
H3RN-1/-11	P2RF-05-E
H3RN-2/-21	P2RF-08-E

Specifications

Item	H3RN-1/-2	H3RN-11/-21
Time ranges	0.1 s to 10 min (1 s, 10 s, 1 min, or 10 min max. selectable)	0.1 min to 10 h (1 min, 10 min, 1 h, or 10 hrs max. selectable)
Supply voltage	24 VAC; 12, 24 VDC	
Operating mode	ON-delay, interval, Repeat cycle ON-start/OFF-start selectable by DIP switch	
Operating voltage	85% to 110% of rated supply voltage (12 VDC: 90% to 110% of rated supply voltage) (see note)	
Power consumption	24 VAC: Relay ON: approx. 0.8 VA (at 24 VAC, 60 Hz) Relay OFF: 0.5 VA (at 24 VAC, 60 Hz) 12 VDC: Relay ON: approx. 0.4 W (at 12 VDC) Relay OFF: 0.1 W (at 12 VDC) 24 VDC: Relay ON: approx. 0.5 W (at 24 VDC) Relay OFF: 0.2 W (at 24 VDC)	
Control outputs	3 A at 250 VAC, resistive load ($\cos\phi = 1$) (G6B-2□14P-FD-US used) The minimum applicable load is 10 mA at 5 VDC (P reference value).	
Repeat accuracy	$\pm 1\%$ FS max. (1 s range: $\pm 1\% \pm 10$ ms max.)	
Setting error	$\pm 15\% \pm 50$ ms FS max.	
Resetting time	Min. power-opening time: 12, 24 VDC: 0.1 s max. (including halfway reset) 24 VAC: 0.5 s max. (including halfway reset)	
Insulation resistance	100 M Ω min. (at 500 VDC)	
Dielectric strength	2,000 VAC, 50/60 Hz for 1 min (between operating circuit and control output, or contacts of different poles) 1,000 VAC, 50/60 Hz for 1 min (between non-continuous contacts)	
Vibration	Mechanical durability	10 to 55 Hz, 0.75-mm single amplitude
	Malfunction durability	10 to 55 Hz, 0.5-mm single amplitude
Shock	Mechanical durability	300 m/s ² (approx. 30G)
	Malfunction durability	100 m/s ² (approx. 10G)
Ambient temperature	Operating	-10°C to 55°C (14°F to 131°F) with no icing
	Storage	-25°C to 65°C (-13°F to 149°F) with no icing
Humidity	Operating	35% to 85%
Service life	Mechanical	10,000,000 operations min. (under no load at 1,800 operations/h)
	Electrical	100,000 operations min. (3 A at 250 VAC, resistive load at 1,800 operations/h)
Noise immunity	± 1.5 kV, square-wave noise by noise simulator (pulse width: 100 ns/1 μ s, 1-ns rise)	
Static immunity	Mechanical durability	8 kV
	Malfunction durability	4 kV
Enclosure rating	IP20	
Weight	Approx. 18 g	
Approvals	UL/CSA/CE (EMC) (LV)	

Note: When using the H3RN in any place where the ambient temperature is more than 50°C, supply 90% to 110% of the rated voltages (12 VDC: 95% to 110% of the rated voltage).

Nomenclature

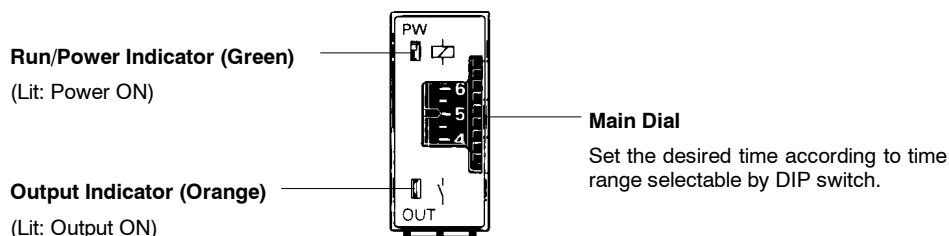

Operation

■ TIMING CHART

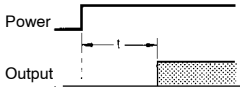
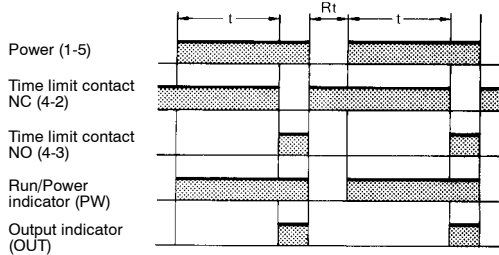
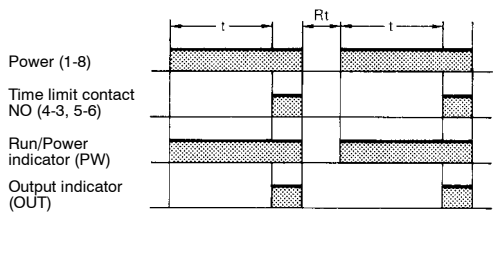
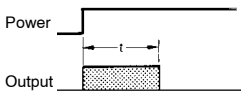
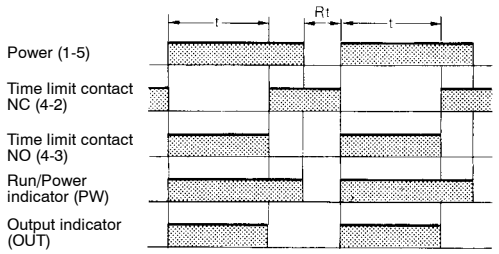
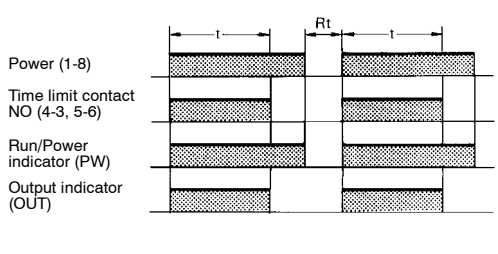
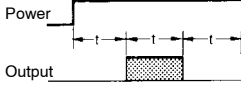
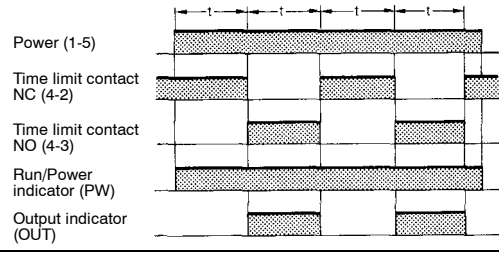
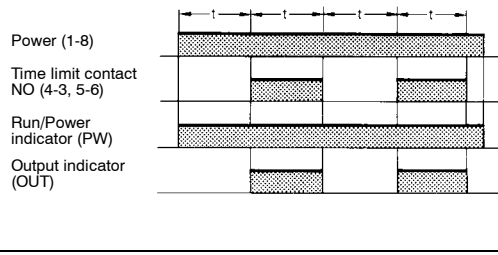
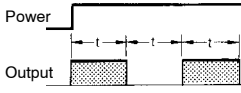
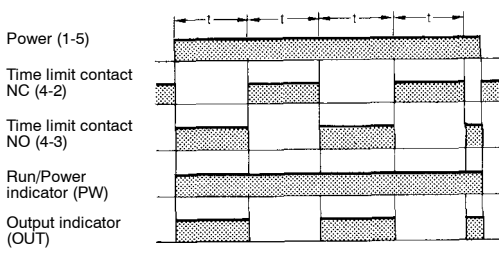
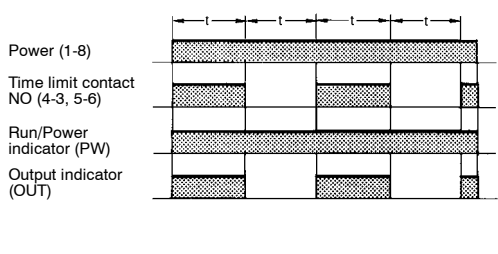
Operating mode	Timing chart	
	H3RN-1/-11	H3RN-2/-21
ON-Delay 		
Interval 		
Repeat-Cycle OFF-start 		
Repeat-Cycle ON-start 		

Note: t: Set time
Rt: Reset time

■ PULSE OPERATION

A pulse output for a certain period can be obtained with a random external input signal. Use the H3RN in interval mode as shown in the following timing charts.

H3RN-2/-21

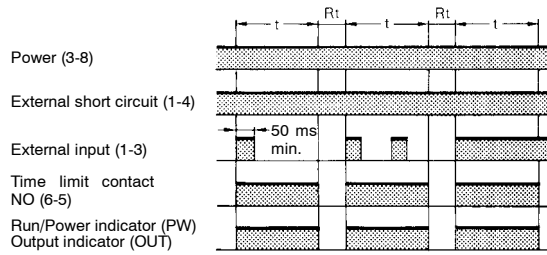
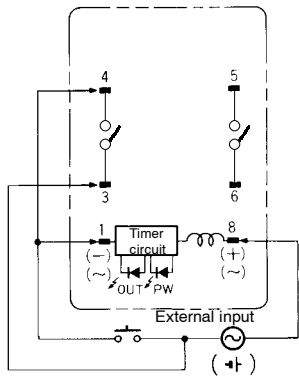

Note: t: Set time
Rt: Reset time

! Caution

Be careful when connecting wires.

Mode	Terminals
Pulse operation	Power supply between 3 and 8 Short-circuit between 4 and 1 Input signal between between 3 and 1
Operating mode: interval and all other modes	Power supply between 1 and 8

■ DIP SWITCH SETTINGS

The 1-s range and ON-delay mode for H3RN-1/-2, 1-min range and ON-delay mode for H3RN-11/-21 are factory-set before shipping.



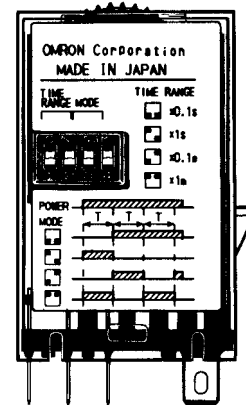

Time Ranges

Model	Time range	Time setting range	Setting	Factory-set
H3RN-1, H3RN-2	1 s	0.1 to 1 s		Yes
	10 s	1 to 10 s		No
	1 min	0.1 to 1 min		No
	10 min	1 to 10 min		No
H3RN-11, H3RN-21	1 min	0.1 to 1 min		Yes
	10 min	1 to 10 min		No
	1 h	0.1 to 1 h		No
	10 h	1 to 10 h		No

Note: The left two DIP switch pins are used to select the time ranges.



Operating Modes

Operating mode	Setting	Factory-set
ON-delay		Yes
Interval		No
Repeat cycle OFF-start		No
Repeat cycle ON-start		No

Note: The right two DIP switch pins are used to select the operating modes.

Dimensions

■ TIMERS

Unit: mm (inch)

H3RN-1/-11

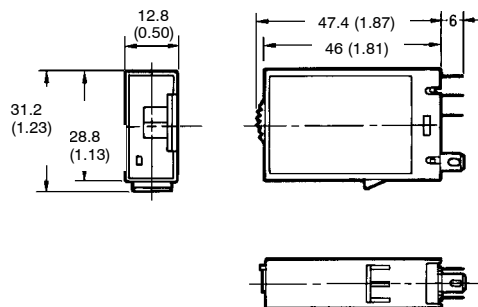
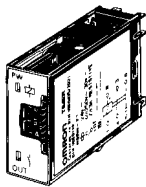

H3RN-2/-21

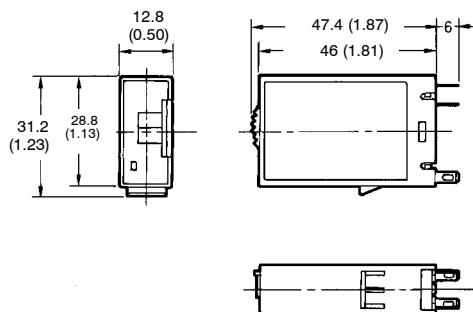
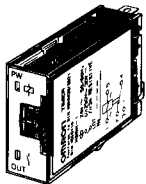

Mounting Height

Use the P2RF-□-E or P2R-□7P to mount the H3RN. When ordering any one of these sockets, replace "□" with "05" for SPDT or "08" for DPST-NO.

P2RF-□-E

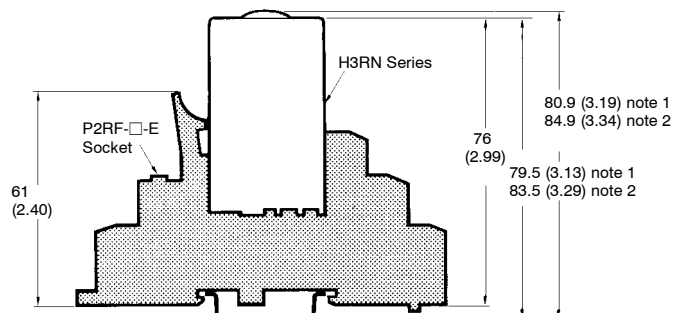

- Note:**
1. The value shown indicates the dimension for the P2RF-05-E with the PFP-□N Mounting Rail. The value is 71.5 mm (2.81) when using the PFP-N□2.
 2. This value indicates the dimension for the P2RF-08-E with the PFP-□N Mounting Rail. The value is 75.5 mm (2.97) when using the PFP-N□2.

Connections

H3RN-1/-11

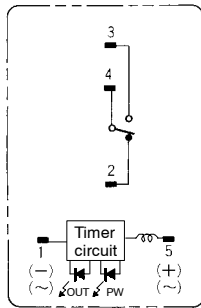

Bottom View

DIN Indication

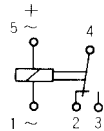

H3RN-2/-21

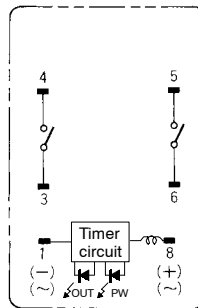

Bottom View

DIN Indication

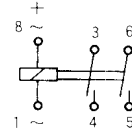

Precautions

When using the H3RN in any place where the ambient temperature is more than 50°C, supply 90% to 110% of the rated voltages (at 12 VDC: 95% to 110%).

Do not leave the H3RN in time-up condition for a long period of time (for example, more than one month in any place where the ambient temperature is high), or the internal parts may become damaged. For this reason, the use of the H3RN with a relay as shown in the following circuit diagram is recommended.

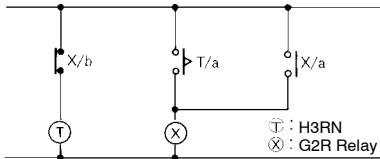

The H3RN must be disconnected from the socket when setting the DIP switch, or the user may touch a terminal imposed with a high voltage and get an electric shock.

Do not connect the H3RN as shown in the following circuit diagram on the right hand side, or the H3RN's internal contacts different from each other in polarity may become short-circuited.

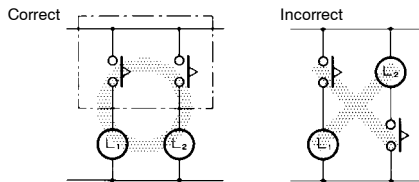

Use the following safety circuit when building a self-holding circuit with the H3RN and an auxiliary relay, such as a G2R Relay, in combination.

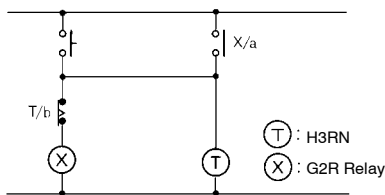

For the above circuit, the H3RN will be in pulse operation.

Do not use the SPDT contact in a circuit which may cause short-circuiting at three points (otherwise, short-circuiting of the power supply may occur) because the SPDT contact of H3RN-1/-11 is composed of an SPST-NC contact.

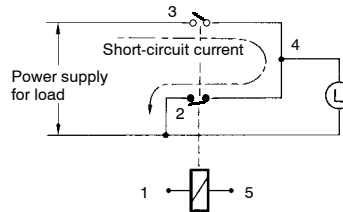

Do not set to the minimum setting in the flicker modes, or the contact may be damaged.

Do not use the H3RN in places where there is excessive dust, corrosive gas, or direct sunlight.

Do not mount more than one H3RN closely together, otherwise the internal parts may become damaged. Make sure that there is a space of 5 mm or more between any H3RN Models next to each other.

The internal parts may become damaged if a supply voltage other than the rated ones is imposed on the H3RN.

Precautions for VDE Conformance

The H3RN as a built-in timer conforms to VDE 0435/P2021 provided that the following conditions are satisfied.

Handling

Do not touch the DIP switch while power is supplied to the H3RN.

Before dismantling the H3RN from the socket, make sure that no voltage is imposed on any terminal of the H3RN.

Wiring

Only a load with basic isolation can be connected to the output contact. The H3YN is a model with basic isolation. Therefore, the H3YN and the load will ensure reinforced isolation, thus meeting VDE standards.

Insulation requirement: Overvoltage category II, pollution degree 2 (with a clearance of 1.5 mm and a creepage distance of 2.5 mm at 240 VAC)

Application Examples

Omron's package-type PLC saves wiring efforts when used in combination with Remote I/O products.

■ APPLICATION 1: SYSMAC BUS REMOTE I/O

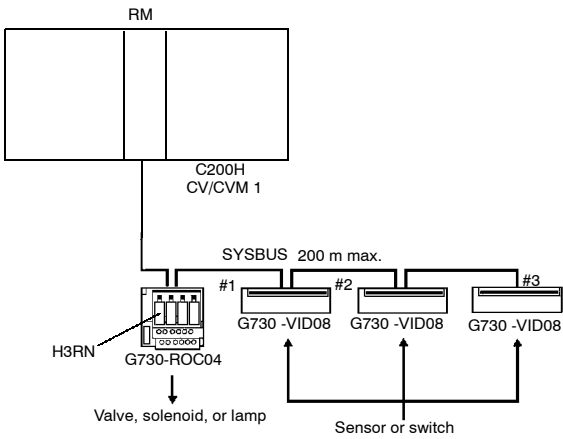

■ APPLICATION 2: CQM1 G730 MASTER

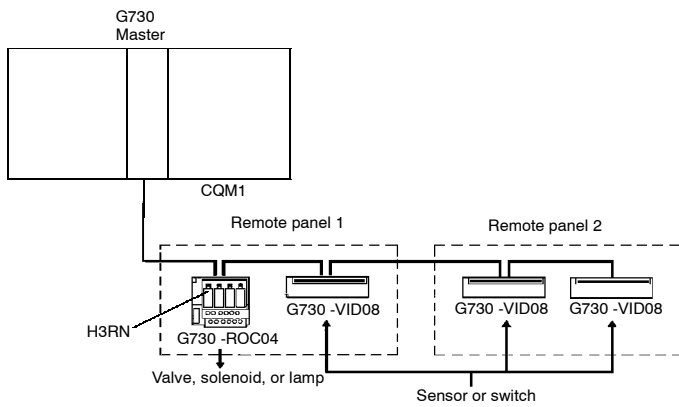

APPLICATION 3: RELAY I/O BLOCKS

Omron Relay I/O Blocks provide industrial I/O to connect to *any* controller or device requiring a hardened I/O structure for isolation from field signals and high level voltages.

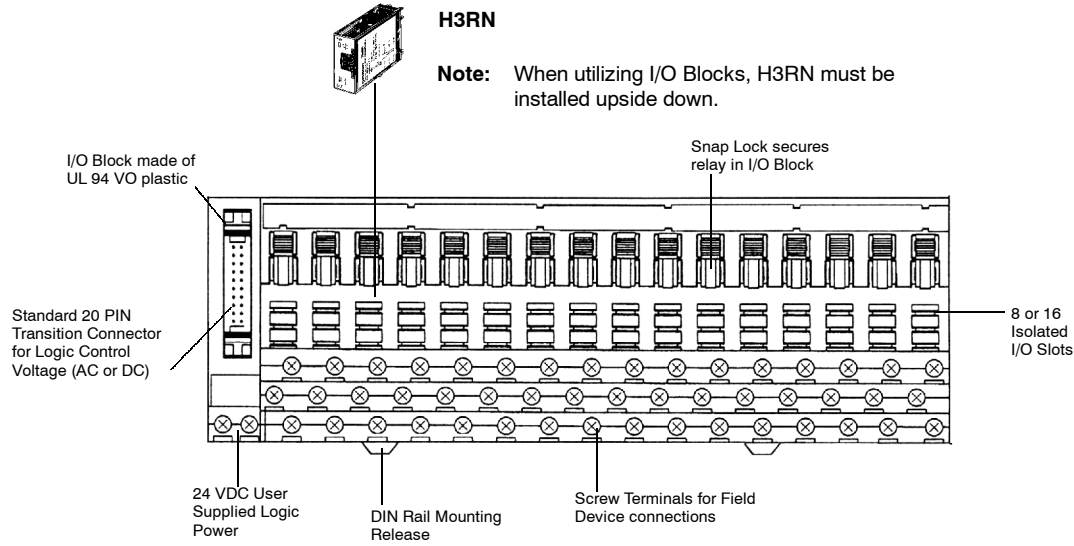

Note: LED indicators on P7TF/G7TC Models only.

Programmable Controller I/O Modules

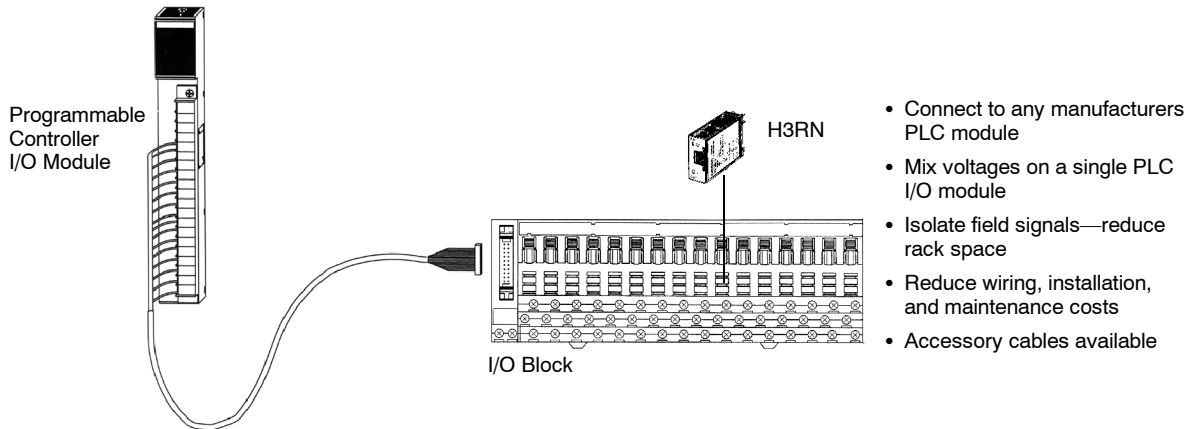

Computers & Embedded Controllers

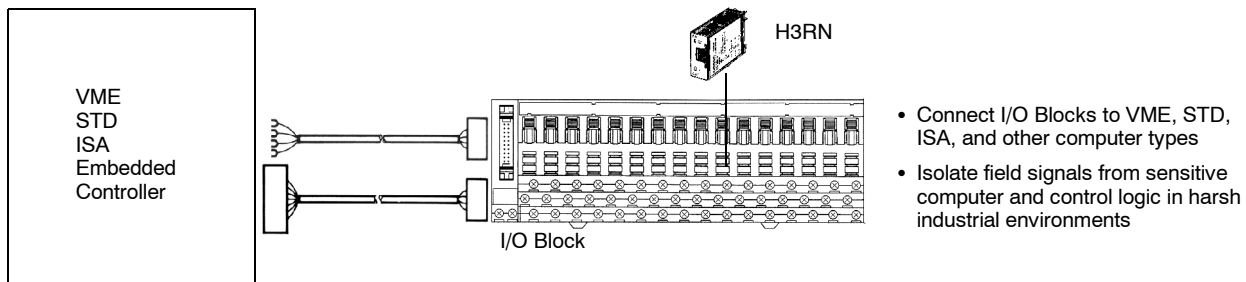

Device Level Network Interfaces

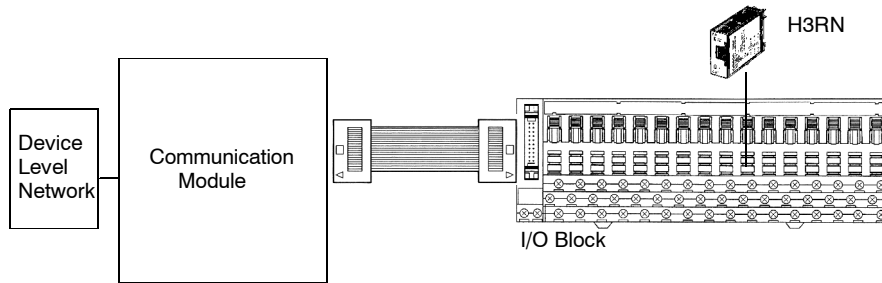

- I/O Blocks connect to any communication interface
- Device level network
- Examples include LonWorks, DeviceNet, ASI Bus, INTERBUS-S, SERIPLEX, and others
- Accessory cables available or use standard ribbon cable connection

NOTE: DIMENSIONS SHOWN ARE IN MILLIMETERS. To convert millimeters to inches divide by 25.4.

OMRON[®]
OMRON ELECTRONICS LLC
 One East Commerce Drive
 Schaumburg, IL 60173
1-800-55-OMRON

OMRON ON-LINE
 Global - <http://www.omron.com>
 USA - <http://www.omron.com/oei>
 Canada - <http://www.omron.com/oci>

OMRON CANADA, INC.
 885 Milner Avenue
 Scarborough, Ontario M1B 5V8
416-286-6465